

# Veriton 3600GT/3600V

User's guide

Copyright © 2003 Acer Incorporated  
All Rights Reserved.

Veriton 3600GT/3600V

User's guide

Original issue date: November 2003

Changes may be made periodically to the information in this publication without obligation to notify any person of such revision or changes. Such changes will be incorporated in new editions of this manual or supplementary documents and publications. This company makes no representations or warranties, either expressed or implied, with respect to the contents hereof and specifically disclaims the implied warranties of merchantability or fitness for a particular purpose.

Record the model number, serial number, purchase date, and place of purchase information in the space provided below. The serial number and model number are recorded on the label affixed to your computer. All correspondence concerning your unit should include the serial number, model number, and purchase information.

No part of this publication may be reproduced, stored in a retrieval system, or transmitted, in any form or by any means, electronic, mechanical, photocopy, recording, or otherwise, without the prior written permission of Acer Incorporated.

Model Number : \_\_\_\_\_

Serial Number: \_\_\_\_\_

Purchase Date: \_\_\_\_\_

Place of Purchase: \_\_\_\_\_

Acer and the Acer Logo are registered trademarks of Acer Inc. Other company's product names or trademarks are used herein for identification purposes only and belong to their respective companies.

1 First things first	1
System specifications	3
Package contents	5
Accessing the user's guide	6
2 System tour	7
Features	9
Performance	9
Multimedia	9
Connectivity	9
Front panel	10
Rear panel - VT3600G	12
Keyboard	14
Internet/E-mail/Search keys	15
Multimedia keys	16
Volume control/Mute keys	17
Lock keys	18
Cursor keys	19
Windows keys	20
Function keys	21
Palm rest	21
Optical drive	22
Hard disk	24
3 Setting up your computer	25
Arranging a comfortable work area	27
Adjusting your chair	27
Positioning your PC	27
Positioning your monitor	30
Positioning your keyboard	30
Positioning your mouse	31
Connecting peripherals	32
Connecting your mouse	32
Connecting your keyboard	34
Connecting a monitor	36
Connecting the power cable	37
Turning on your computer	38
Turning off your computer	39
Connecting options	40
Connecting your printer	40
Connecting the modem (optional)	41
Connecting to the network	42
Connecting multimedia devices	43

# Contents

Connecting USB devices	46
4 Upgrading your computer	47
Installation precautions	49
ESD precautions	49
Preinstallation instructions	49
Post-installation instructions	50
Opening your computer	51
To remove the computer cover	51
To replace the computer cover	52
Internal components	53
System boards	54
Mainboard layout	54
Audio board	57
Upgrading your computer	58
Installing additional memory	58
Replacing the hard disk	60
Installing an expansion card	63
5 System utilities	65
Acrobat Reader	68
Acer LANScope (optional)	69
Norton AntiVirus	70
NTI CD-Maker	
(for models with CD-RW)	72
PowerDVD (for models with DVD)	74
BIOS utility	75
Reinstalling programs	76
Recovering your system	77
Using Backup (Windows XP only)	82
Disk Defragmenter (Windows XP only)	83
6 Frequently asked questions	85
Appendix A: Notices	91
Energy Star Guidelines Compliance	92
FCC notice	92
Notice: Canadian users	93
Declaration of Conformity for EU countries	93
Modem notices	93
Important safety instructions	94
Macrovision copyright protection notice	95

Lithium battery statement	96
Laser compliance statement	96
Declaration of Conformity for CE marking	98
Federal Communications Commission	
Declaration of Conformity	99
Appendix B: Taking care of your computer	101
Important tips	102
Cleaning and servicing	102
Asking for technical assistance	103
Index	105



1 First things  
first

This chapter describes the system specifications and the contents of your computer package.



# System specifications

Component	Specification
Processor	<ul style="list-style-type: none"> <li>Intel® Pentium® 4 2.0~3.6 GHz</li> <li>Intel® Celeron® 2.0 - 2.6 GHz</li> </ul>
System memory	Four SDRAM slots support a maximum of 4 GB dual-channel DDR memory
Chipset	<ul style="list-style-type: none"> <li>Intel® 865G+ICH5(3600GT)</li> <li>Intel® 865GV+ICH5(3600V)</li> </ul>
Graphics	Intel® 865G supporting: <ul style="list-style-type: none"> <li>DVMT technology</li> <li>Dual Display</li> </ul>
Audio	AC '97 Codec
LAN	10/100/1000 Base-T Gigabit Ethernet connectivity
IDE	Two 40 pin parallel ATA IDE slots Two Serial ATA ports
FDD	1.44 MB 3.5 inch floppy drive
PS/2	<ul style="list-style-type: none"> <li>PS/2 keyboard port</li> <li>PS/2 mouse port</li> </ul>
USB	Eight external USB 2.0 ports
Serial port	One serial port on I/O bracket (Optional 2nd serial port connecting via "COM2" on page 55)
Printer port	One parallel printer port
Thermal	Dynamic fan speed control
Security	<ul style="list-style-type: none"> <li>Chassis lock pad</li> <li>Chassis intrusion alarm</li> </ul>

Component	Specification
Wake system	Wake on LAN Wake on modem Mouse/keyboard
HDD	<ul style="list-style-type: none"> <li>• Paralle ATA (5400, 7200 RPM)</li> <li>• Serial ATA (7200 RPM)</li> </ul>
Optical Drive	CD-ROM, CD-RW, DVD-ROM, DVD/CD-RW combo or DVD+/-RW, or DVD-RAM(Supermulti plus) drive
Operating system	<ul style="list-style-type: none"> <li>• Windows® 2000</li> <li>• Windows® XP Home</li> <li>• Windows® XP Professional</li> <li>• Novell®/SCO® Unix/Red Hat® Linux (driver support)</li> </ul>
Dimensions	<ul style="list-style-type: none"> <li>• Small Form Factor 345mm(H) /101.3mm(W) /414.7mm(D)</li> </ul>
Weight	<ul style="list-style-type: none"> <li>• Small Form Factor 5.3 kg/11.7lb</li> </ul>
Thermal overrides	<ul style="list-style-type: none"> <li>• System temp &gt;90°C - functions suspended until system temp is below 90°C</li> <li>• CPU temp &gt;110°C - functions suspended until CPU temp is below 110°C</li> <li>• CPU temp &gt;120°C - system auto-shutdown</li> </ul>

# Package contents

Before you unpack your computer, make sure that you have enough space to set up your computer.

Carefully unpack the carton and remove the contents. If any of the following items are missing or damaged, contact your dealer immediately:

- Veriton 3600 series
- Items contained in the accessory box
  - Foot stands
  - USB or PS/2 keyboard
  - USB or PS/2 mouse
  - Power cable
- User's guide and installation poster
- Other user documentation and third-party software

# Accessing the user's guide

This user's guide is also available on your computer as an Adobe Acrobat PDF file.

## To access the user's guide (for Windows® XP)

- 1 On the Windows® XP taskbar, click on the Start button then select Help and Support Center.
- 2 On the Help and Support Center home page, double-click the Veriton 3600 series Online icon.

## To access the user's guide (for Windows® 2000)

- 1 Double-click on the Veriton 3600 series Online icon on your Windows® desktop.

## 2 System tour

This chapter discusses the features and components of your computer.

# Features

Here are just a few of your computer's many features:

## Performance

- Intel® Pentium® 4/Celeron® supporting FSB(Front Side Bus) up to 800 /400MHz and HyperThreading Technology™
- Intel® 865G+ICH5 (for 3600GT) or 865GV+ICH5(for 3600V) chipset
- DDR-SDRAM 400/333/266, 4 DIMM slots, Expandable to 4GB dual-channel memory
- Power management function
- CD-ROM, CD-RW, DVD-ROM, DVD/CD-RW combo, DVD+/-RW, or DVD-RAM(Supermulti plus) drive
- High-capacity, Enhanced-IDE hard disk

## Multimedia

- 3-D quality audio system via onboard audio controller
- Audio-in/Line-in, Audio-out/Line-out, Headphone-out, and Microphone-in interfaces



**Note:** The system has two microphone-in jacks (front and rear). However, you can not use both of them at the same time. By default, your system enables the microphone-in jack in front.

## Connectivity

- Two PS/2 interfaces for mouse and keyboard
- One serial port(Option 2nd serial port via "COM2" on page 55)
- One parallel port
- One VGA port
- Eight Universal Serial Bus (USB) 2.0 ports (four on the front and four on the rear panel)
- High-speed fax/data PCI modem (optional)
- Gigabit Ethernet LAN support with remote wake-up function

# Front panel

Your computer's front panel consists of the following:

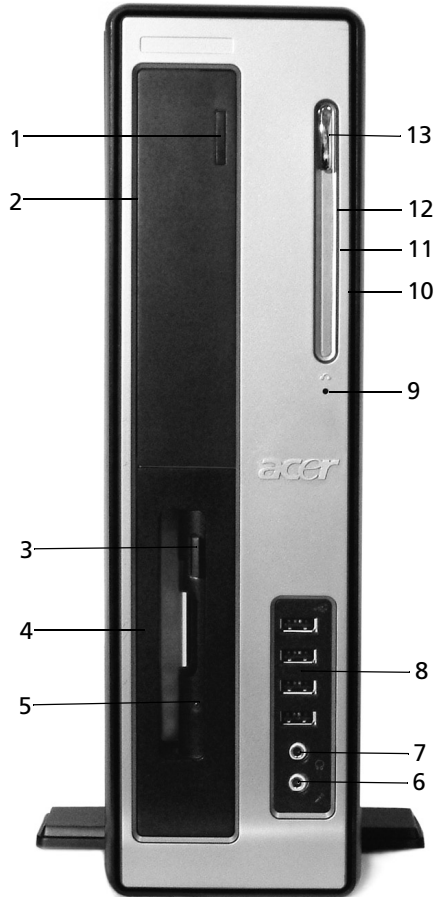







Label	Icon	Component
-------	------	-----------

1	■	5.25-inch drive Stop/Eject button
---	---	-----------------------------------

---



Label	Icon	Component
2		5.25-inch optical drive bay
3		Floppy drive eject button
4		3.5-inch floppy drive
5		Floppy drive light-emitting diode (LED)
6		Microphone-in jack (front) <sup>see note</sup>
7		Headphone-out port
8		USB ports
9		OBR(One Button Recovery) slot
10		Hard disk activity LED
11		LAN activity LED
12		Power LED
13		Power button











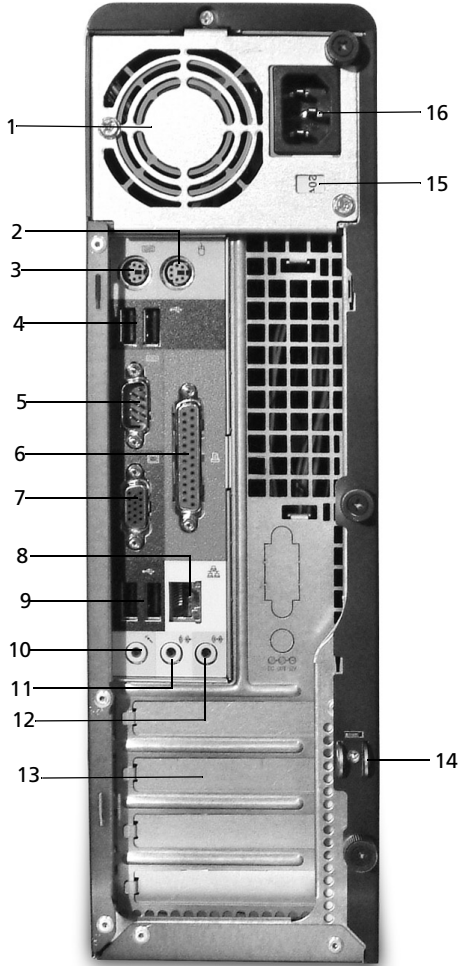

**Note:** The system has two microphone-in jacks (front and rear). However, you can not use both of them at the same time. By default, your system enables the microphone-in jack in front and disables the one at the back.

For information on how to connect the peripherals, see “Connecting peripherals” on page 32 and “Connecting options” on page 40.

# Rear panel

Your computer's rear panel consists of the following:



Label	Icon	Color	Component
1			Power supply
2		Green	PS/2 mouse port
3		Purple	PS/2 keyboard port
4/9		Black	USB ports
5		Teal or Turquoise	Serial port
6		Burgundy	Parallel/Printer port
7		Blue	Monitor port (On-die VGA)
8		White	Network port
10		Pink	Microphone-in jack (rear)
11		Lime	Audio-out/Line-out jack
12		Light blue	Audio-in/Line-in jack
13			Expansion slots
14			Chassis lock pad
15			Voltage selector switch
16			Power cord socket

For information on how to connect the peripherals, see “Connecting peripherals” on page 32 and “Connecting options” on page 40.

# Keyboard

The keyboard that came with your computer has full-sized keys that include separate cursor keys, two Windows keys, four multimedia keys and twelve function keys.

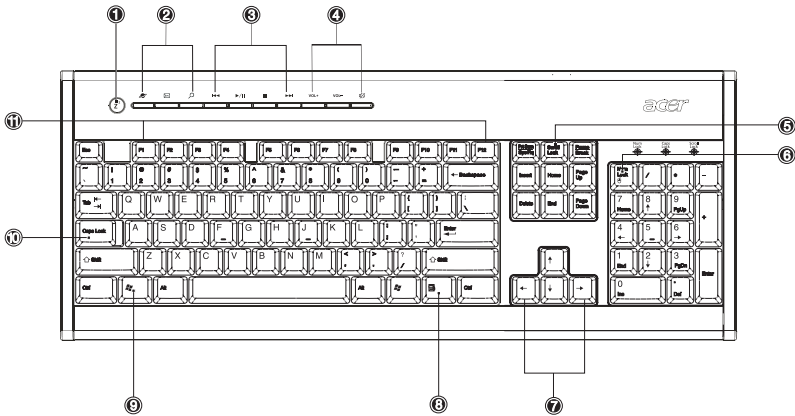

For information on how to connect your USB keyboard, please see “Connecting peripherals” on page 32.

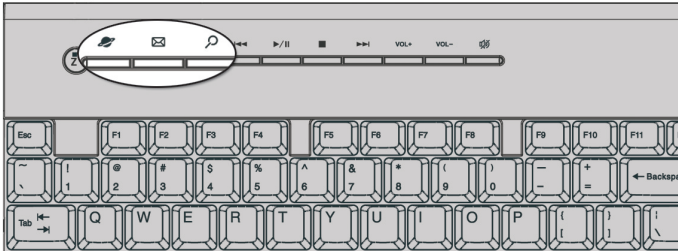

No.	Description	No.	Description
1	Sleep button	2	Internet/E-mail/Search keys
3	Multimedia keys	4	Volume control/Mute keys
5	Scroll lock key	6	Num lock key
7	Cursor keys	8	Application key
9	Windows logo key	10	Caps lock key
11	Function keys		

## Internet/E-mail/Search keys





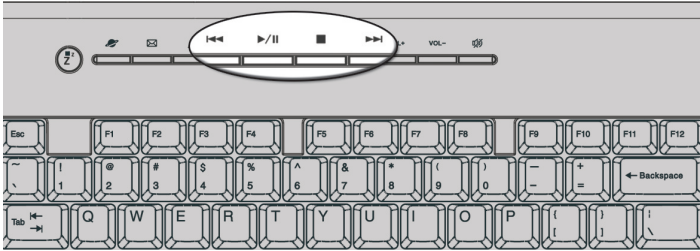

Icon	Key	Description
	Web browser	Launches your current default browser.
	Email	Launches your email application.
	Search	Opens a search window.

## Multimedia keys

Allow you to conveniently play, pause, stop, step forward, or step back a song or movie using your keyboard.



Icon	Key	Description
	Backward	Press to skip backward to the previous track or video file and start playing.
	Play/Pause	Press to start playing the audio track or video file. Press again to pause.
	Stop	Press to stop playing the audio track or video file.
	Forward	Press to skip forward to the next track or video file and start playing.

## Volume control/Mute keys

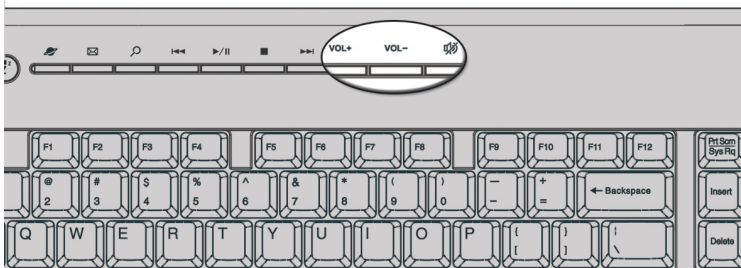

Icon	Key	Description
<b>VOL+</b>	Volume up	Press to increase audio volume.
<b>VOL-</b>	Volume down	Press to decrease audio volume.
	Mute	Toggle sound on/off.

## Lock keys

The keyboard has three lock keys which you can toggle on and off to switch between two functions.

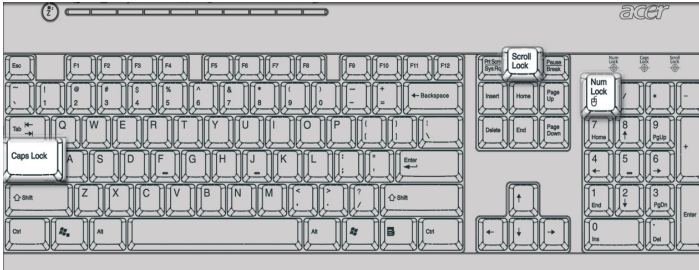

Lock key	Description
Scroll Lock	When activated, the screen moves one line up or down when you press the up arrow or down arrow respectively. Take note that Scroll Lock may not work with some applications.
Num Lock	When activated, the keypad is set to numeric mode; i.e., the keys function as a calculator (complete with arithmetic operators such as +, -, * and /).
Caps Lock	When activated, all alphabetic characters typed appear in uppercase (same function as pressing Shift + <letter>).



## Cursor keys

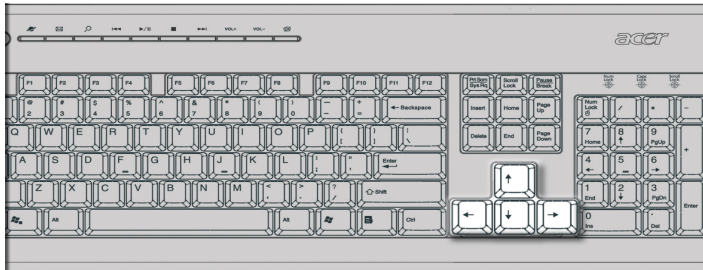

The cursor keys, also called the arrow keys, let you move the cursor around the screen. They serve the same function as the arrow keys on the numeric keypad when the Num Lock is toggled off.

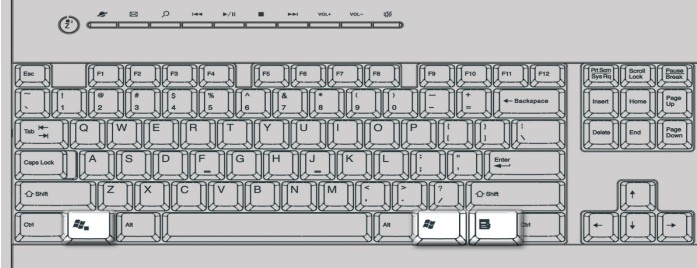

# Windows keys

The keyboard has two keys that perform Windows-specific functions.



Key	Description
Windows logo key 	Start button. Combinations with this key perform special functions, such as: <ul style="list-style-type: none"> <li>• <b>Windows + Tab</b>: Activate the next Taskbar button</li> <li>• <b>Windows + E</b>: Explore My Computer</li> <li>• <b>Windows + F</b>: Find Document</li> <li>• <b>Windows + M</b>: Minimize All</li> <li>• <b>Shift + Windows + M</b>: Undo Minimize All</li> <li>• <b>Windows + R</b>: Display the Run dialog box</li> </ul>
Application key 	Opens the applications context menu (same function as clicking the right button of the mouse).

## Function keys

The function keys, F1 - F12, let you perform specific functions, depending on the application that uses them.

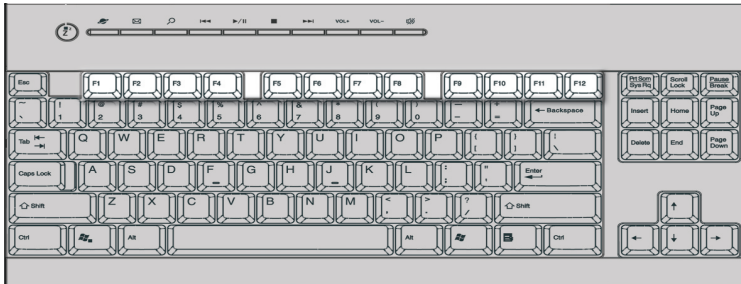

## Palm rest

The detachable palm rest provides you a comfortable place to rest your hands while typing.

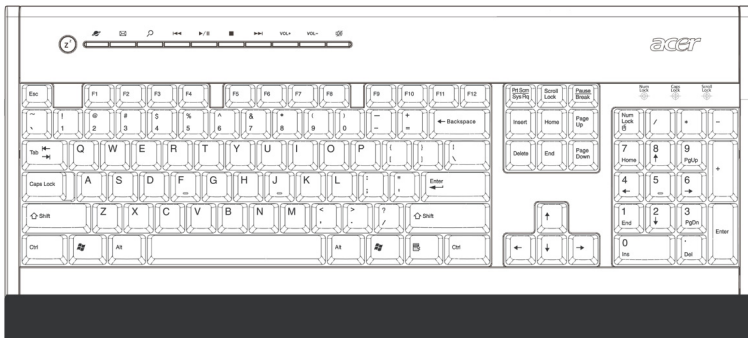

# Optical drive

Your computer may come with a CD-ROM, DVD-ROM or a combo DVD/CD-RW, DVD+/-RW, or DVD-RAM(Supernulti plus) drive. This drive is located on the front panel of your computer. The CD-ROM drive allows you to play different types of compact discs (CDs). The DVD-ROM drive allows you to play not only old CD-ROMs, CD-I discs, and video CDs, but digital video discs (DVDs) as well. DVD or DVD-ROM is a type of disc media that holds a minimum of 4.7-GB (gigabytes), enough for a full-length movie. The CD-RW drive allows you to record or burn CD-RW (recordable and rewritable) discs.

CDs and DVDs, like diskettes, are also compact, lightweight, and easy to carry around. However, they are more delicate than diskettes and must be handled with extra care.

To insert a CD or DVD into your computer's CD-ROM or DVD drive:

- 1 Gently push the Eject button located on the front panel.



- 2 When the disc tray slides open, place the CD or DVD gently on the tray. Make sure that the label or title side of the disc is facing upward. When holding a disc, hold it by the edges to avoid leaving smudges or fingerprints.



- 3 Push the Eject button again to close the tray.

### To take care of your CDs and DVDs:

- Keep your discs in a disk case when not in use to avoid scratches or other damage. Any kind of dirt or damage can affect the data on the disc, impair the disc lens reader on the CD or DVD drive, or stop the computer from successfully reading the disc.
- When handling discs, always hold them by the edges to avoid smudges or fingerprints.
- When cleaning discs, use a clean, dust-free cloth and wipe in a straight line from the center to the edge. Do not wipe in a circular motion.
- Clean your CD or DVD drive periodically. You may refer to the Cleaning kit for instructions. Cleaning kits can be purchased in any computer or electronics shop.

# Hard disk

Your computer is preinstalled with a high-capacity Enhanced-IDE (E-IDE) hard disk.

Refer to “Replacing the hard disk” on page 60 for instructions on how to upgrade or replace your hard disk.

# 3 Setting up your computer

This chapter contains step-by-step instructions on how to set up your computer and connect additional peripherals.



## Arranging a comfortable work area

Working safely begins with the arrangement of your work space and the proper use of equipment. For this reason, it is very important to take time and think about how you are going to arrange your work area.

Here are some points to consider:

### Adjusting your chair

Having the right kind of chair does not necessarily mean that you'll be properly supported. It is necessary to adjust your chair to fit your body. Proper body posture will make you more comfortable and productive.

- Avoid tilting your chair. If you have a chair that tilts, lock the tilt knobs so that your chair will not tilt forward or backward while you are using your computer.
- Adjust your chair height in such a way that you can sit on it with your thighs parallel to the floor and your feet resting flat on the floor.
- Rest your body on the chair back. Your torso works harder to maintain balance if you do not rest your body on the chair back.

### Positioning your PC

You may position your computer in two ways:

- Tower-like/vertical position
- Regular desktop position

#### To position your PC in a tower or vertical position:

- 1 Install the foot stands.  
Press the notch on both sides of the foot stands (a).

- 2 Turn out the foot stands to the slots on the housing frame (b) as shown in the figure below:



To position your PC in a desktop or horizontal position:

- 1 Attach the foot stands as shown in the figure that follows.

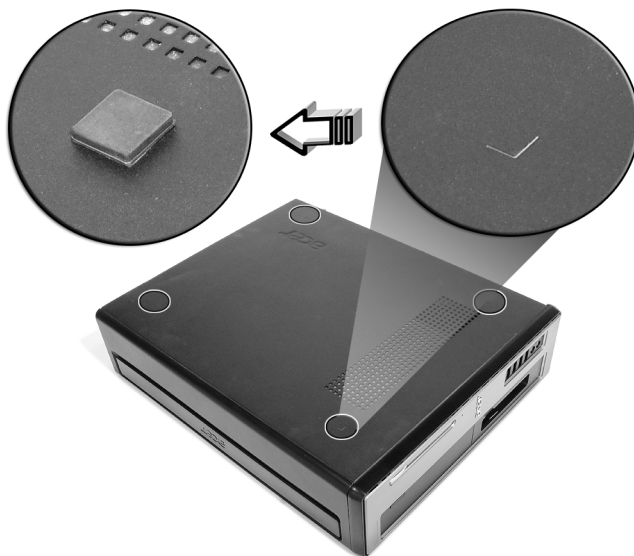

- 2 Place your computer in the desired location.

Take note of the following when selecting a location for your computer:

- Do not put your computer near any equipment that might cause electromagnetic or radio frequency interference such as radio transmitters, televisions, copy machines, or heating and air-conditioning equipment.
- Avoid dusty areas and extremes of temperature and humidity.
- You may place your computer beside your desk or under your table, as long as it does not block the space that you need for working and moving.

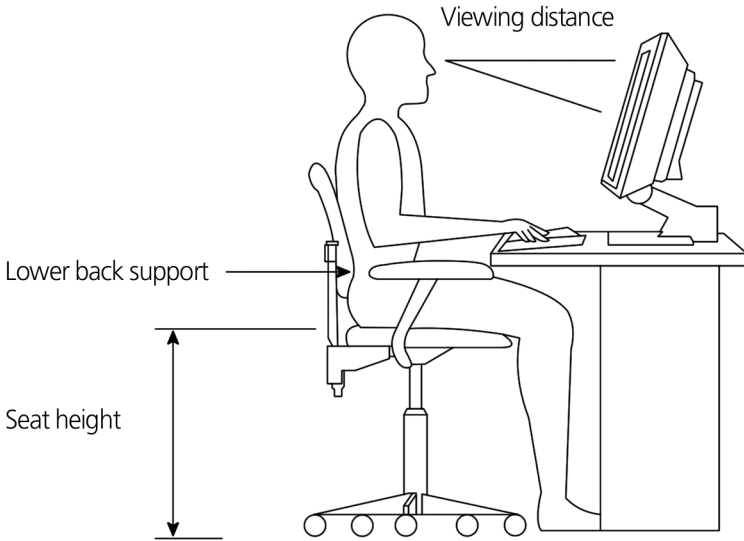

## Positioning your monitor

Place your monitor at a comfortable viewing distance, usually 50 to 60 centimeters away. Adjust the display in such a way that the top of the screen is at or slightly below eye level.

## Positioning your keyboard

The location of the keyboard is a very important factor to your posture. Placing it too far away will make your body lean forward forcing you to sit in an unnatural position. Placing it too high will add tension to your shoulder muscles.

- The keyboard should be placed just above your lap. Adjust the keyboard height by flipping the folding stands located under the keyboard.
- Keep your lower arms parallel to the floor as you type. Your upper arms and shoulders should be relaxed. Then try typing with a light touch. If you feel any shoulder or neck strain, stop for a while and check your posture.
- Position your keyboard in front of your monitor. Putting your

keyboard beside your monitor will make you turn your head while you type which could add tension to your neck muscles that may later result in neck strain.

## Positioning your mouse

- The mouse should be placed on the same surface as your keyboard so that you can reach it with ease.
- Adjust its position to allow enough space for movement without making you stretch or lean over.
- Use your arm to move the mouse. Do not rest your wrist on the table when moving the mouse.

# Connecting peripherals

Setting up your computer is easy. For the most part, you only have four things to connect: the mouse, the keyboard, the monitor, and the power cable.



-----  
**Note:** The peripherals shown in the connections below are for your reference only. Actual device models may vary in select countries.

## Connecting your mouse

### USB mouse

Plug your USB mouse cable into any of the USB ports (black) located on the front and rear panels of your computer.



## PS/2 mouse

Plug the PS/2 mouse cable into the PS/2 mouse port  (green port) located on the rear panel of your computer.



# Connecting your keyboard

## USB keyboard

Plug your USB keyboard cable into any of the USB ports (black port) located on the front and rear panel of your computer.

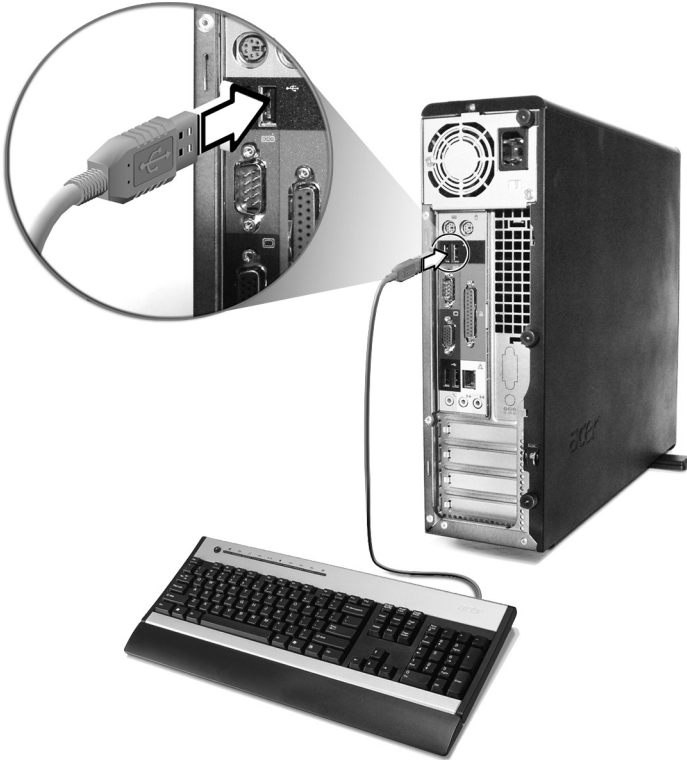



## PS/2 keyboard

Plug your PS/2 keyboard cable into the PS/2 keyboard port  (purple port) located on the rear panel of your computer.



## Connecting a monitor

To connect a monitor, simply plug the monitor cable into the monitor port  (blue port) located on the rear panel of your computer.



.....  
**Note:** Refer to the monitor manual for additional instructions and information on adjusting your monitors settings.



.....  
**Note:** The image above shows the Vertion 3600G. Refer to pages 16 and/or 18 for the location of your monitor port(s).

## Connecting the power cable



**Caution!** Before you proceed, check the voltage range in your area. Make sure that it matches your computer's voltage setting. If they don't match, set your computer's voltage selector switch to the voltage range applicable to your area.

Set the voltage selector switch to the voltage range applicable to your area. Plug the power cable into the power cable socket located on the rear panel of your computer. Then plug the other end of the power cable into a power outlet.



## Turning on your computer

After connecting the necessary peripherals and plugging in the power cable, you are now ready to turn the computer on and get to work.

To turn on your computer:

- 1 Turn on all peripherals connected to your computer such as the monitor, printer, fax, speakers, etc.
- 2 On the front panel of your computer, press the Power button.



**Important:** Make sure that the power cable is properly plugged into an electrical outlet. If you are using a power strip or an AVR (Auto-Voltage Regulator), make sure that it is plugged in and turned on.

# Turning off your computer

To turn off your computer, follow the steps below.

For Windows® XP:

- 1 On the Windows® XP taskbar, click on the Start button, and click Turn Off Computer; then click Turn Off.
- 2 Turn off all peripherals connected to your computer.

For Windows® 2000:

- 1 On the Windows® 2000 taskbar, click on the Start button, highlight Shut Down, select Shut down from the drop down window then click on OK.
- 2 Turn off all peripherals connected to your computer.

If you cannot shut down your computer normally, press the power button for at least four seconds. Quickly pressing the button may put the computer in Suspend mode only.

# Connecting options

## Connecting your printer

Your computer supports parallel, serial and USB printers.

To connect a parallel printer, plug the printer cable into the parallel port  (burgundy port) located on the rear panel of your computer.



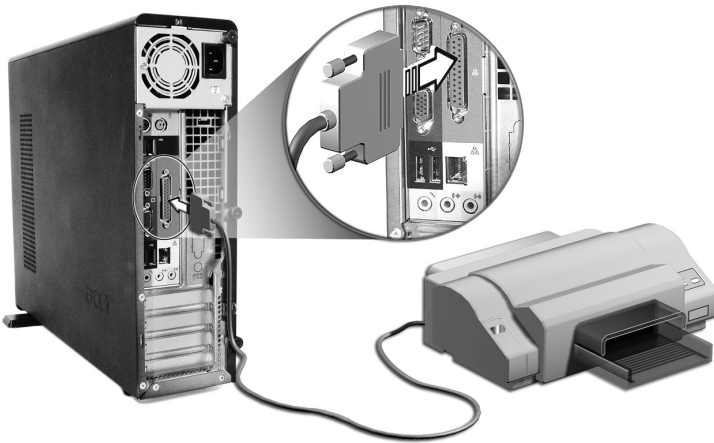

.....  
**Note:** The printer shown below is for your reference only. Actual device model may vary in select countries.



.....  
**Note:** If you are using a serial printer, connect the printer cable into the serial port located on the rear panel of your computer. In the same manner, connect a USB printer by plugging the printer cable into any of the USB ports located on the front or rear panels.

## Connecting the modem (optional)

Set up your modem connection by plugging the telephone line  and handset line  into their corresponding ports on the rear panel of your computer.

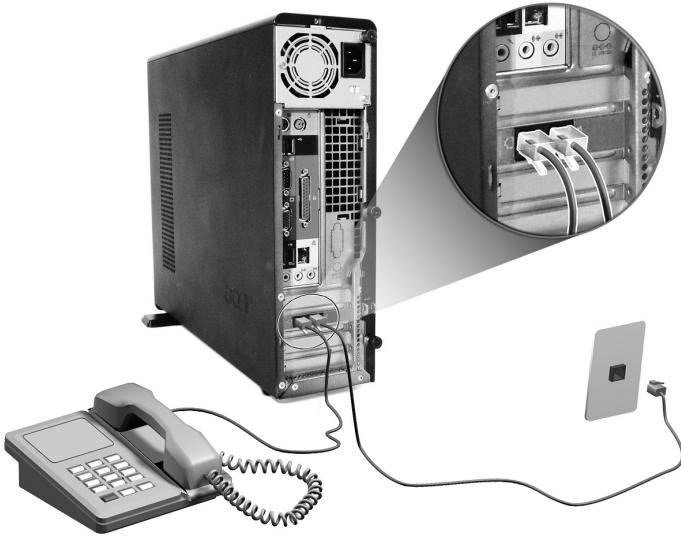

## Connecting to the network

You can connect your computer to a Local Area Network (LAN) using a network cable. To do so, simply plug the network cable into the network port  (white port) on the rear panel of your computer.



-----  
**Note:** Consult your network system administrator or operating system manual for information on how to configure your network setup.



## Connecting multimedia devices

You can connect multimedia devices such as microphone, earphone or headphone, external speakers, and audio line-in device. These devices will allow you to take advantage of your computer's multimedia features.



.....

**Note:** The multimedia devices shown below are for your reference only. Actual device models may vary in select countries.

Plug the devices in as follows:



.....

**Note:** For information on how to configure multimedia devices, consult the documentation that came with each device.

- microphone: connects to the microphone-in jack  (pink port) located on the front and rear panel of your computer



.....

**Note:** The system has two microphone-in jacks (front and rear). However, you can not use both of them at the same time. By default, your system enables the microphone-in jack in front and disables the one at the back.



- earphones, headphones: connect to the Headphone-out port (lime port) located on the front panel of your computer 



.....

**Note:** To adjust the volume of the headphones, click on the Volume icon located on the taskbar at the bottom of your screen. When the Volume control pops up, drag the Volume control lever to the desired level. You can also use the Volume control button on the keyboard.

- external speakers: connect to the Audio-out/Line-out jack  (lime jack) on the rear panel of your computer



- audio line-in device: connect to the Audio-in/Line-in jack (🔊) (light blue jack) located on the rear panel of your computer



## Connecting USB devices

Universal Serial Bus (USB) is a serial bus design that is capable of cascading peripherals such as a digital camera, keyboard, mouse, joystick, scanner, printer and modem. With USB, complex cable connections can be eliminated.

Your computer comes with eight USB ports: four on the front and another four on the rear panel. These ports support USB 2.0 high-performance external devices such as webcams and digital still cameras. They also allow you to connect additional USB devices to your computer without using up its system resources.

To connect a USB device, simply plug the device cable into any of the USB ports  (black port).



.....  
**Note:** Some USB devices have a built-in USB port which allows you to connect or daisy-chain more USB devices.

# 4 Upgrading your computer

This chapter contains instructions on how to upgrade your computer and basic information about your system boards that you will find helpful when performing the upgrade process.

# Installation precautions

Before you install any computer component, we recommend that you read the following sections. These sections contain important ESD precautions along with preinstallation and post-installation instructions.

## ESD precautions

Electrostatic discharge (ESD) can damage your processor, disk drives, expansion boards, and other components. Always observe the following precautions before you install a computer component:

- 1 Do not remove a component from its protective packaging until you are ready to install it.
- 2 Wear a wrist grounding strap and attach it to a metal part of the computer before handling components. If a wrist strap is not available, maintain contact with the computer throughout any procedure requiring ESD protection.

## Preinstallation instructions

Always observe the following before you install any component:

- 1 Turn off your computer and all the peripherals connected to it before opening it. Then unplug all cables from the power outlets.
- 2 Open your computer according to the instructions on page 51.
- 3 Follow the ESD precautions described above before handling a computer component.
- 4 Remove any expansion boards or peripherals that block access to the DIMM sockets or component connector.
- 5 See the following sections for specific instructions on the component you wish to install.



.....  
**Warning! Not turning off the computer properly before you start installing the components may cause serious damage.**

**Do not attempt the procedures described in the following sections unless you are a qualified service technician.**

## Post-installation instructions

Observe the following after installing a computer component:

- 1 See to it that the components are installed according to the step-by-step instructions in their respective sections.
- 2 Replace any expansion boards or peripherals that you removed earlier.
- 3 Replace the computer cover.
- 4 Connect the necessary cables and turn on your computer.



## Opening your computer



**Caution:** Before you proceed, make sure that you have turned off your computer and all peripherals connected to it. Read the “Preinstallation instructions” on page 49.

You need to open your computer before you can install additional components. See the following section for instructions.

### To remove the computer cover

- 1 Turn off your computer and unplug all cables.
- 2 Place your computer on a flat, steady surface. If your computer is in the vertical position, remove the foot stands and place your computer in the regular desktop position.
- 3 Turn the thumbscrews counterclockwise with your fingers to release the cover.

Hold the sides of the cover with both hands.

Slide it back about an inch and then gently lift it upward to detach it.



## To replace the computer cover

- 1 Align the cover's hinges to the housing frame; then gently push it in to slide it back into place.

Secure the cover with thumbscrews.



## Internal components

The figure below shows what your computer looks like once you remove the cover:

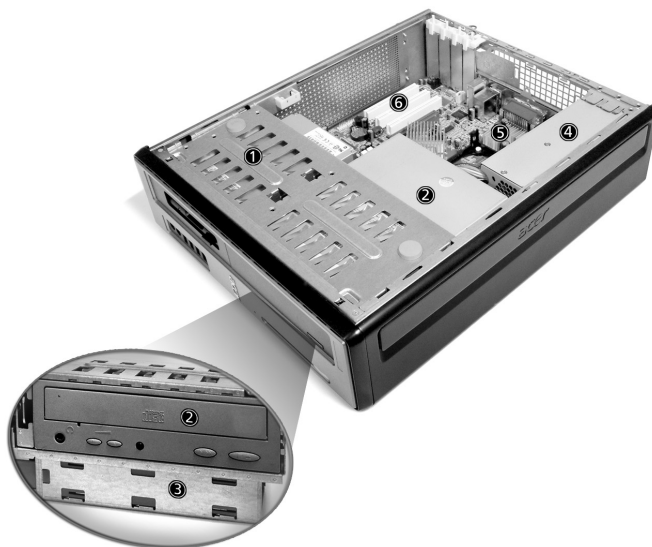

Number	Component
1	3.5-inch floppy drive
2	Optical drive
3	Drive frame
4	Power supply
5	Mainboard <small>see note</small>
6	Expansion slot



**Note:** The mainboard model shown in the figure above may not be exactly the same with the one found in your computer.

# System boards

## Mainboard layout

The mainboard becomes accessible once you open your computer. Refer to the section below for the corresponding mainboard layout of your Veriton 3600 series computer model.

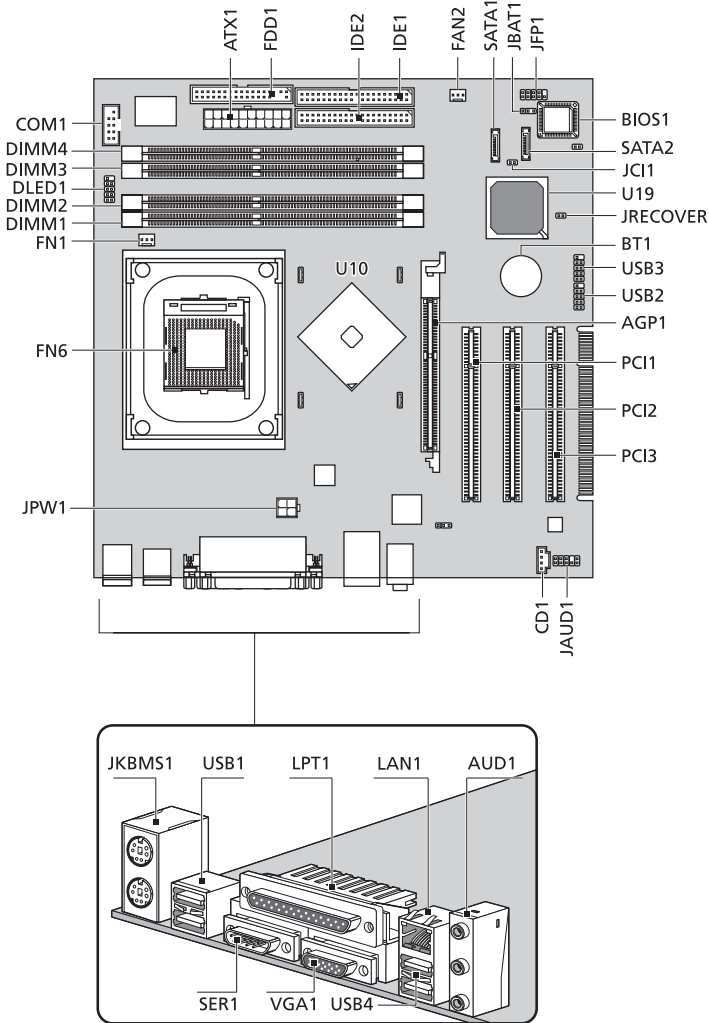

Label	Component
AGP1	AGP slot (VT3600GT only) <sup>see note</sup>
AUD1	Line-in (top), line-out (middle), and rear microphone-in (bottom) ports
ATX1	Power connector
BIOS1	BIOS chipset
BT1	Battery
CD1	CD-in connector
COM2	Serial connector
DLED1	D-Bracket (LANScope) connector
DIMM1 DIMM2 DIMM3 DIMM4	DIMM sockets 1-4
FN1	3-pin CPU fan connector
FN6	CPU ZIF socket
FAN2	3-pin system fan connector
FDD1	FDD connector
IDE1	IDE 1 connector
IDE2	IDE 2 connector
JAUD1	Audio FPIO connector
JBAT1	1-2 Normal 2-3 Clear CMOS
JCI1	Intrusion connector

Label	Component
JFP1	HDD LED, Power LED connector Power button and Reset switch controller
JKBMS1	PS/2 mouse (upper) and keyboard (lower) ports
JPW1	Power connector (12V power)
JRECOVER	One Touch Recovery button connector
LPT1	Parallel/Printer port
PCI1 to PCI3	PCI slots 1 to 3
SATA1 SATA2	Serial HDD connectors
SER1	Serial port
U10	Northbridge
U19	Southbridge
USB1	USB ports
USB2	Front USB 2.0 connector
USB3	Front USB 2.0 connector
USB4	USB ports
VGA1	Monitor port



**Note:** For the location of the AGP slot on the Veriton 3600 mainboard, see page 54.

## Audio board

The audio board that came with your computer should look like the figure that follows

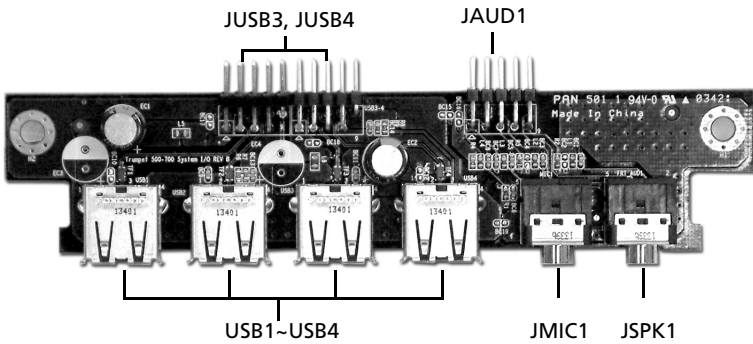

Label	Description
JUSB1	USB Connector - connects to the JUSB2 of the mainboard
JUSB2	USB Connector - connects to the JUSB3 of the mainboard
USB1 to USB4	USB ports
JAUD1	Standard audio connector - connects to the JAUD1 of the mainboard
JMIC1	Microphone-in jack
JSPK1	Audio-out port



**Note:** The system has two microphone-in jacks (front and rear). However, you can not use both of them at the same time. By default, your system enables the microphone-in jack in front and disables the one at the back.

# Upgrading your computer

Certain components of your computer are upgradeable such as the memory, the hard disk, the CPU and the expansion cards. You need to observe the “Installation precautions” on page 49 when installing or removing a computer component. However, for safety purposes, we do not recommend that you perform these upgrades yourself. If you want to replace or upgrade any of these components, contact your dealer or a qualified service technician for assistance.



.....  
**Note:** The mainboard model shown in the following figures may not be exactly the same with the one found in your computer.

## Installing additional memory

The four 184-pin sockets on the mainboard support Double Data Rate (DDR) Synchronous Dynamic Random Access Memory (SDRAM)-type DIMMs. You may install 128-MB, 256-MB, 512-MB or 1-GB DIMMs for a maximum memory capacity of 4 GB.

The DDR DIMMs should work under 2.5 volts. You can install PC2100/DDR266, PC2700/DDR333, or PC3200/DDR400 modules in the DDR DIMM sockets. Contact your dealer for qualified DIMM vendors.

Each DDR DIMM socket is independent from the other. This independence allows you to install DDR DIMMs with different capacities to form different configurations.

## To remove a DDR DIMM



.....  
**Note:** The DDR DIMM has only one notch located on the center of the module.

- 1 Remove the computer cover (see page 51).
- 2 Locate the DDR DIMM socket on the mainboard.



- 3 Press the holding clips on both sides of the DDR DIMM socket outward to release the DDR DIMM (1,2). Gently pull the DDR DIMM out of the socket (3).

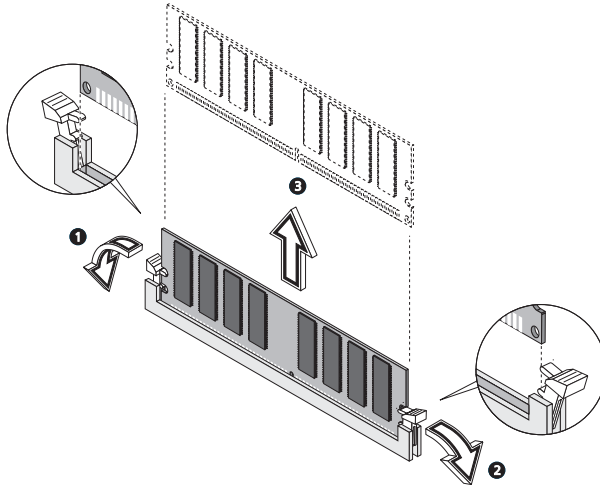

## To install a DDR DIMM

- 1 Locate the DDR DIMM socket on the mainboard.

- 2 Align the DDR DIMM with the socket (1). Press the DDR DIMM into the socket until the clips lock onto the DDR DIMM (2,3).

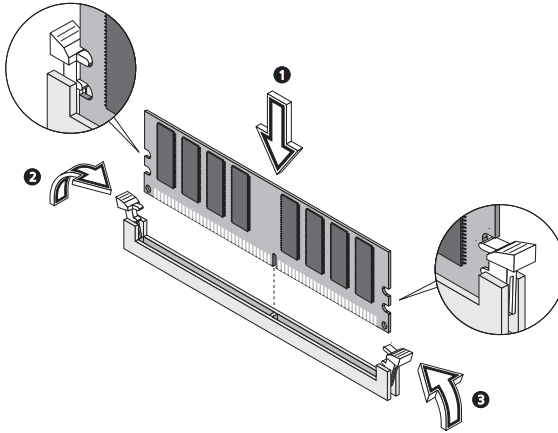

**Note:** The DDR DIMM sockets are slotted to ensure proper installation. If you insert a DDR DIMM but it does not fit easily into the socket, you may have inserted it incorrectly. Turn the DDR DIMM around and try to insert it again.

## To reconfigure your computer

Your computer automatically detects the amount of memory installed. Run the BIOS utility to view the new value for total system memory and make a note of it.

## Replacing the hard disk

Follow these steps to replace your computer's hard disk:

- 1 Remove the computer cover (see page 51).
- 2 Detach all cables connected to the CD or DVD drive, the 3.5-inch floppy drive and hard disk.

- 3 Lift the drive frame to a 90-degree angle; then pull out, and remove the drive frame.

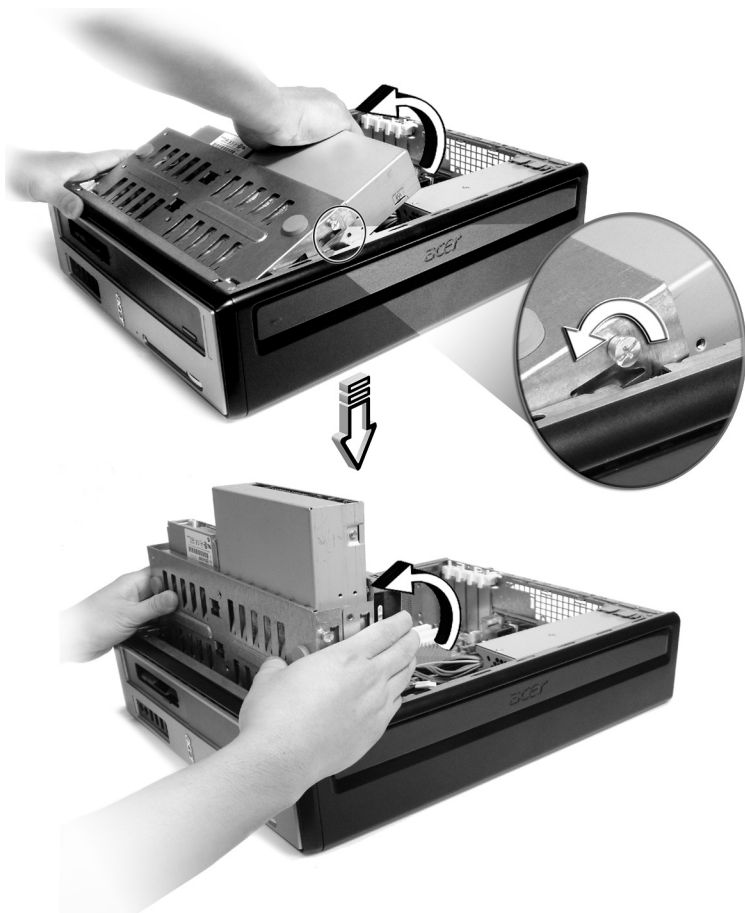

- 4 Pull out the drive rails that hold the hard disk to the housing. Set the drive rails aside.

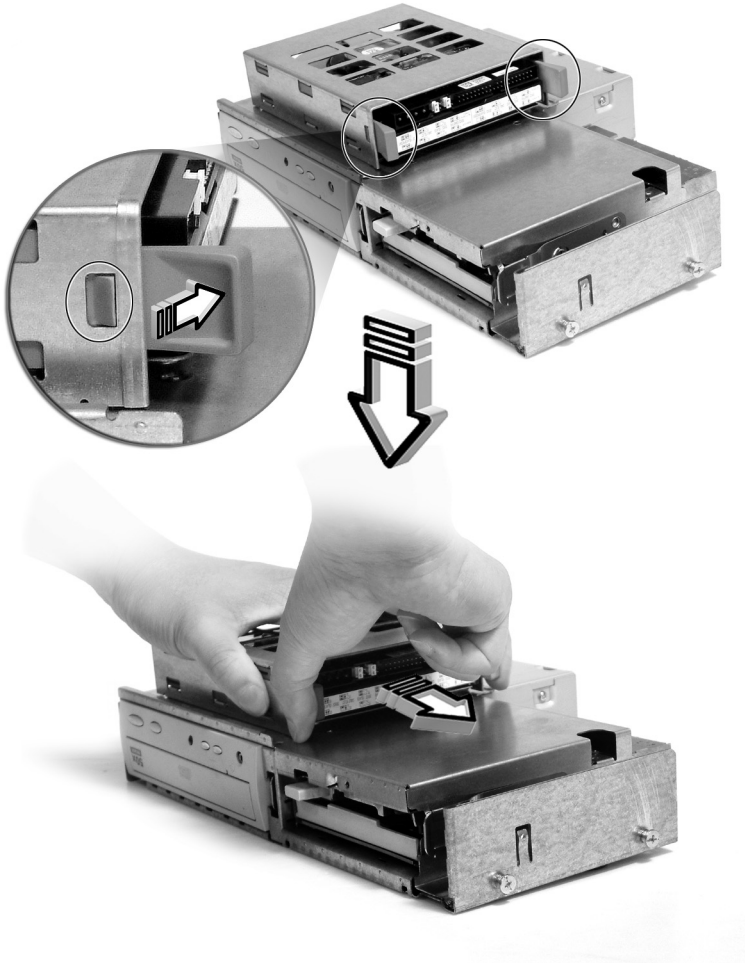

- 5 Slide the hard disk frame to the left (d); then gently move it out (e) and pull it up to detach it (f).

- 6 Install the new hard disk into the housing. Secure it with the drive rails you removed earlier and connect the power and hard disk cables to the new hard disk.
- 7 Reinstall the drive frame into the housing.
- 8 Reattach the CD or DVD drive and the floppy drive cables.



.....

**Note:** Make sure that the other ends of the disk drive cables are securely connected to their corresponding connectors on the mainboard.

- 9 Replace the computer cover (see page 52).

## Installing an expansion card

To install an expansion card:



.....

**Caution:** Your system accepts low profile PCI cards only.

- 1 Remove the computer cover (see page 51).
- 2 Locate an empty PCI slot on the mainboard.
- 3 Remove the bracket lock that holds the bracket to the computer. Save the bracket lock.
- 4 Pull out the bracket on the housing opposite the selected empty slot.
- 5 Remove the expansion card from its protective packaging.
- 6 Align the card with the empty bracket and then insert it into the slot. Make sure that the card is properly seated.
- 7 Secure the card to your computer with the bracket lock you removed earlier.
- 8 Replace the computer cover (see page 52).

When you turn on the computer, BIOS (Basic Input/Output System) automatically detects and assigns resources to the newly-installed devices.



# 5 System utilities

This chapter describes applications that are preinstalled on your computer.



Depending on the hardware and optional features installed in your computer, your system came bundled with several program utilities designed to streamline your computer's operations. These utilities may include any of the following:

- Acrobat® Reader™
- Acer LANScope Client Manager (optional)
- Norton AntiVirus
- NTI CD-Maker
- PowerDVD
- BIOS utility
- Acer One Button Recovery (System restore utility)

If your computer is configured with Microsoft Windows XP the following utilities can be used to monitor and maintain system health.

- Backup
- Disk Defragmenter

All of the applications that came with your computer are very easy to use. However, if you need more help and information, you may refer to the online help documentation provided in each software application.

# Acrobat Reader

Acrobat Reader is a software that lets you view, navigate, browse and print Adobe Portable Document Format (PDF) files on all major computer platforms.



To read a PDF document  you can:

- Simply double click on any file with an icon like that shown above.
- or
- 1 On the windows taskbar, click on the Start button, highlight Programs, and select Acrobat Reader.
  - 2 Once the program is running, select Open from the File menu.
  - 3 Select the file you wish to view in the Open file browser and click the Open button.

For more information about Acrobat Reader, you may refer to the Acrobat Reader Help menu.

## Acer LANScope (optional)

Acer LANScope allows desktop management via the Web, standard network, or dial-up connections. It is compatible with the leading management specifications, such as Wired for Management 2.0, Desktop Management Interface (DMI) v2.0, and others.

Your computer may be bundled with a LANScope installation CD. To install LANScope:

- 1 Insert the LANScope installation CD into the optical drive.



.....

**Caution!** Make sure that the LANScope installation CD is properly inserted into the optical drive. Improper insertion may damage both the CD and the drive.

Refer to page 22 for instructions on how to insert a CD into your computer's optical drive.

- 2 Follow all onscreen instructions until installation is completed.

For more information on how to use the LANScope, you may refer to the LANScope Help menu.



.....

**Note:** Acer LANScope currently supports Windows 98, Windows Me, Windows 2000 and Windows XP platforms.

# Norton AntiVirus

Norton AntiVirus is an anti-virus software which finds and repairs infected files, protects against viruses to keep your computer data safe and secure. It also scans incoming email attachments for viruses. It provides useful virus detection and repair facilities.

## How do I check for viruses using Norton AntiVirus?

A full system scan scans all files on your computer. To perform a system scan:

- 1 Start Norton AntiVirus
  - Double click on the Norton AntiVirus Icon on the desktop
  - or
  - Click on the Start menu in the Windows taskbar, highlight Programs, and select Norton AntiVirus.
- 2 In the Norton AntiVirus main window, click Scan for Viruses.

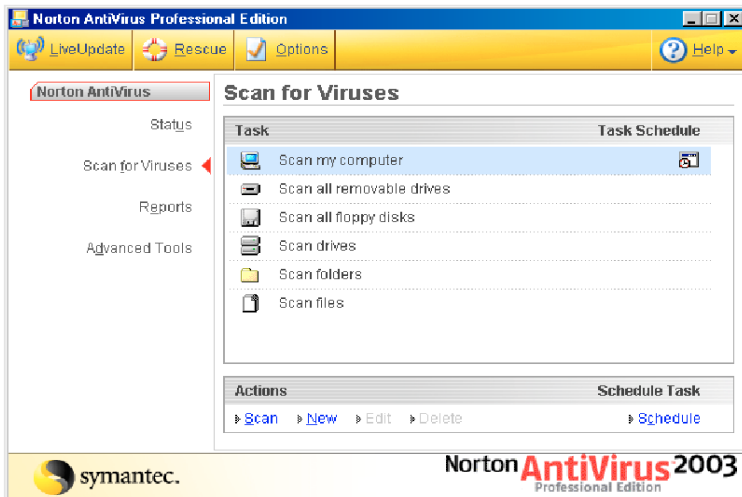

- 3 In the Scan for Viruses pane, click Scan My Computer.
- 4 Under Actions, click Scan.

When the scan is complete, a scan summary appears.

- 5 When you are done reviewing the summary, click Finished.

You can schedule customized virus scans that run unattended on specific dates and times or at periodic intervals. If you are using the computer when the scheduled scan begins, it runs in the background so that you do not have to stop working.

For more information about Norton AntiVirus, including setting up custom scans and scheduling scans, refer to the Norton AntiVirus Help menu.

# NTI CD-Maker (for models with CD-RW)

The NTI CD-Maker is a CD-Recording software which allows you to create and copy audio, data and videos to CD-R or CD-RW discs.

To copy an audio or data disc:



- 1 Click the Quick Burning icon **Quick Burning** on the desktop.
- 2 Insert the CD you would like to copy into the source drive and a blank disc into the target drive.
- 3 Choose the source and target drives from the pull-down lists.

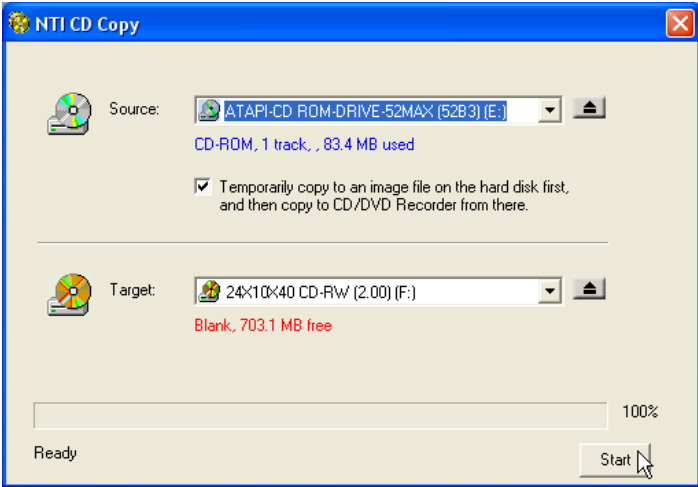

- 4 Click the Start button to begin copying.

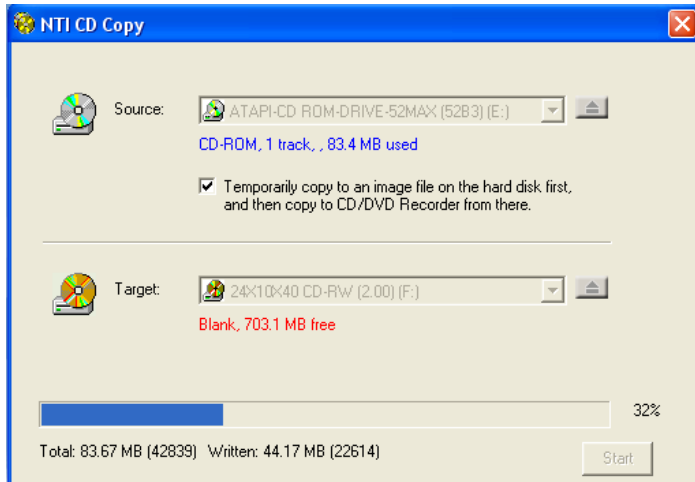

For more information about NTI CD-Maker and its other features, refer to the NTI CD-Maker Help menu.

## PowerDVD (for models with DVD)

PowerDVD is a high-quality, pure software DVD player which brings high-quality movies and karaoke to your multimedia PC. You can play back high resolution DVD titles or MPEG-2 files with MPEG-2 video and Dolby Digital (AC-3) audio. PowerDVD provides a complete set of commands for navigation and advanced features such as multi-angle switching, multi-language and multi-subtitle selection, and parental control. It also has the i-Power Internet Enabling feature, which links to online DVD resources via the Power DVD Desktop Portal Page.

### How do I open PowerDVD and watch a DVD?

In most cases, when you insert a DVD into your computer's optical drive, PowerDVD will automatically open a viewer window and the control panel and begin playing.



If PowerDVD does not open automatically:

- 1 Click the Start button in the taskbar.
- 2 Highlight All Programs
- 3 Click the Cyberlink PowerDVD tab
- 4 Select PowerDVD

When PowerDVD opens simply press the play button  to begin playback.

For more information about Cyberlink PowerDVD and its other features, refer to the PowerDVD Help menu.



## BIOS utility

The BIOS utility is a hardware configuration program built into your computer's Basic Input/Output System (BIOS). Since most computers are already properly configured and optimized, there is no need to run this utility. However, if you encounter configuration problems and get the "Run Setup" message, you will need to run this utility.



.....

**Note:** Before you run BIOS, make sure that you have saved all open files. The computer reboots immediately after you exit Setup.

To run the BIOS utility, press the **Del** key on your keyboard during computer boot up.

## Reinstalling programs

If you uninstall one of the preinstalled programs and want to reinstall it, do the following:

- 1 Make sure that the system is turned on.
- 2 Insert the System CD into the CD or DVD drive.
- 3 Select the application that you want to reinstall.
- 4 Follow all onscreen instructions until you finish the installation.

## Recovering your system

If your operating system files are lost or damaged, the recovery process will restore your system's original factory default settings or last system backup. Your Acer Veriton series computer includes an OBR(One Button Recovery) button, a feature that makes restoring your system quick and easy.

OBR works from a hidden partition on your hard drive that contains all the information required to restore your system.

There are two modes to recovery your system. One is from system's original settings and another is from system backup. You can press Alt + F10 after the BIOS finishes running the Power On Self Test (POST).



.....  
**Warning: Initiating the recovery operation while the operating system is running will result in abnormal shutdown and may make your current OS unstable or unusable.**

After the POST runs, you have only 1.5 seconds to press Alt + F10. Follow all onscreen instructions.

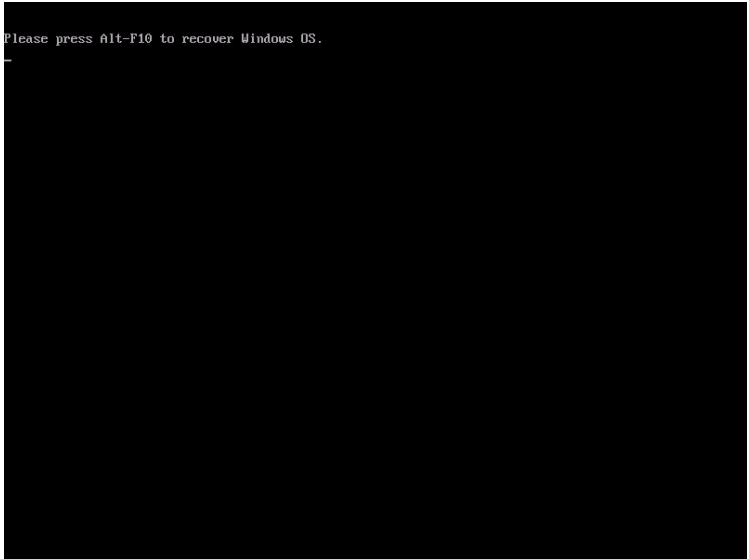

Please press Alt-F10 to recover Windows OS.

You can also follow the steps below:

- 1 Locate the OBR button. See the image on page 10.
- 2 Press the button. After a moment one of the following screen will appear on your display
  - a when you don't backup your system yet..

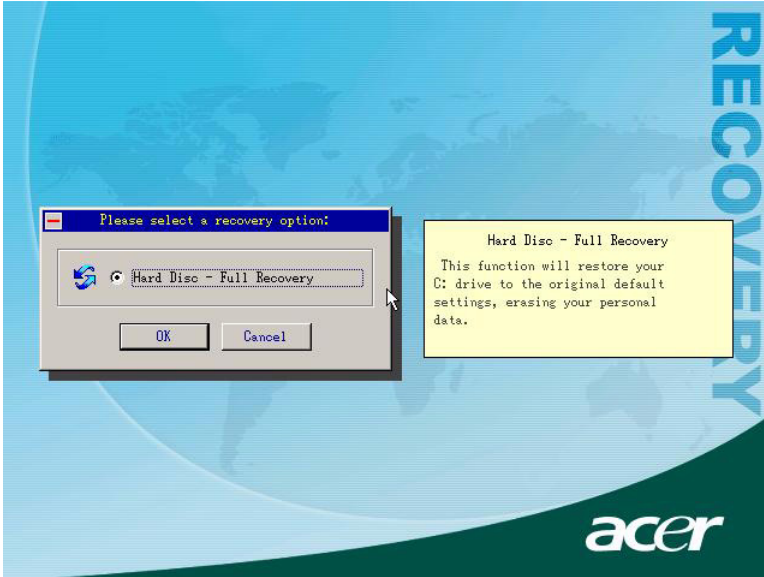

b after you backup your system

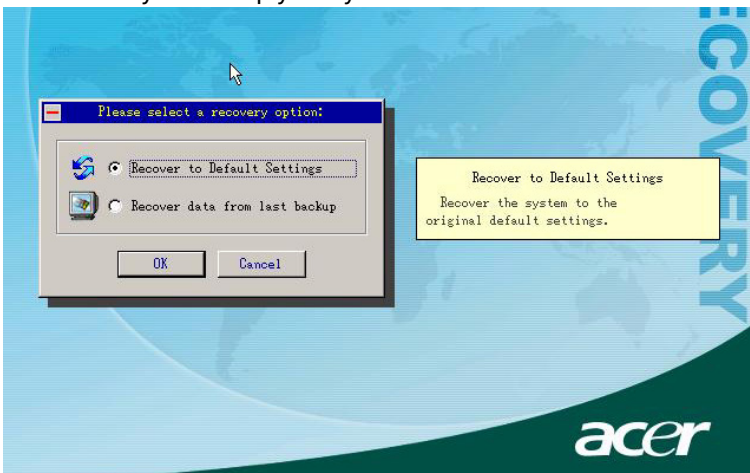

- 3 In 2-a, click OK. You will be prompted again. In 2-b, select "Recover to Default Settings" to restore your system to the default factory settings. Select "Recover data from last backup" to restore your system to the last time system backup.



.....

**Note:** Click "Backup System" icon on the desktop to backup your system anytime.

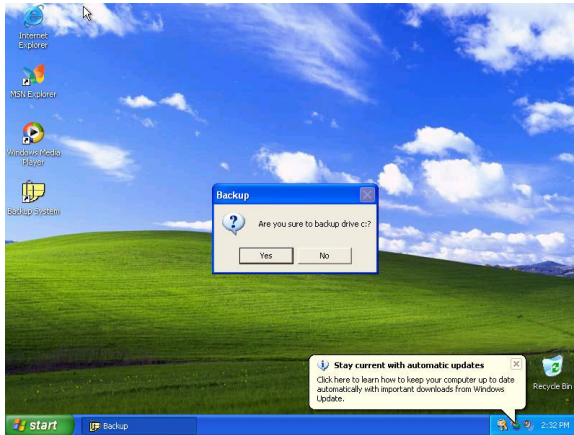

- 4 If you chose your recovery option, you should see the following screen. Click OK to continue.

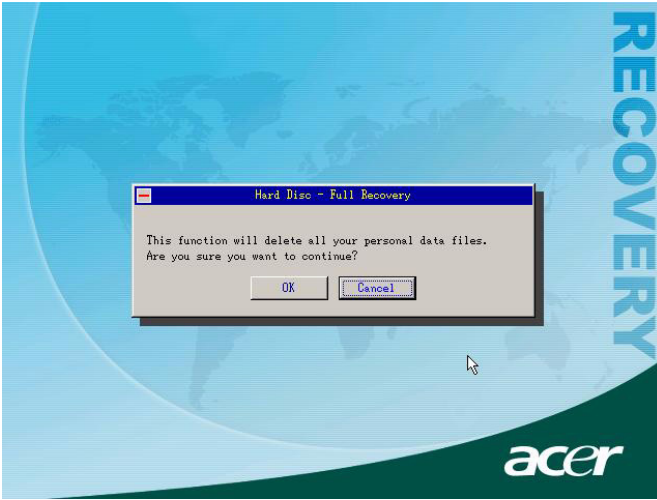

- 5 After 15 seconds the system will reboot and initiate the restore operation.

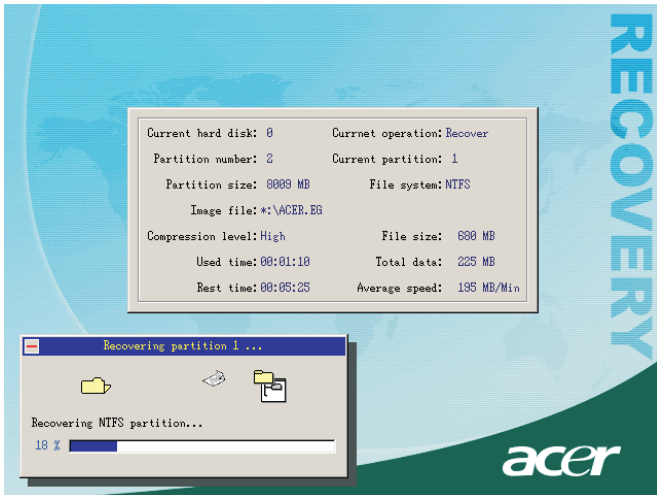

- 6 After the recovery operation finishes the system will reboot. You will be required to go through the setup process again.

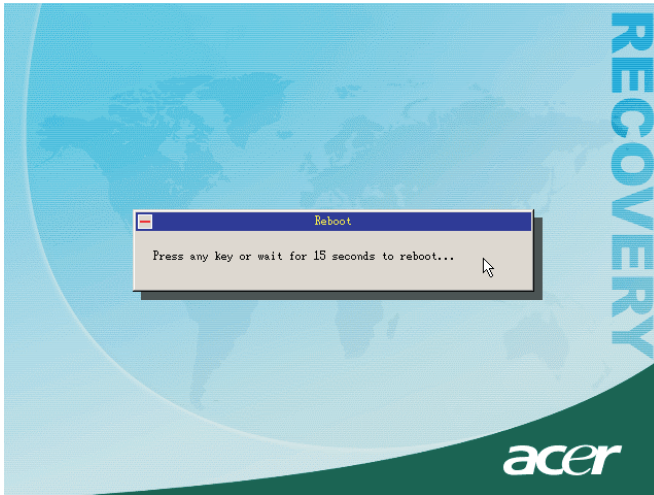

**Caution!** Running the Recovery operation will erase all files previously saved in your computer so make sure to back up your important files before starting the recovery process.

If you attempt to restore your system using the One Button Recovery feature, and the system DOES NOT respond, contact your local vendor or authorised Acer representative immediately.

# Using Backup (Windows XP only)

The Backup utility creates copies of information on your hard disk. In the event that the original data on your hard disk is erased or overwritten, or becomes inaccessible because of a hard disk malfunction, you can use the copy to restore your lost or damaged data.

## How do I back up files from my hard drive?

To run the Backup utility:

- 1 Click the Start button in the taskbar.
- 2 Highlight All Programs
- 3 Click Accessories
- 4 Select System Tools
- 5 Click Backup

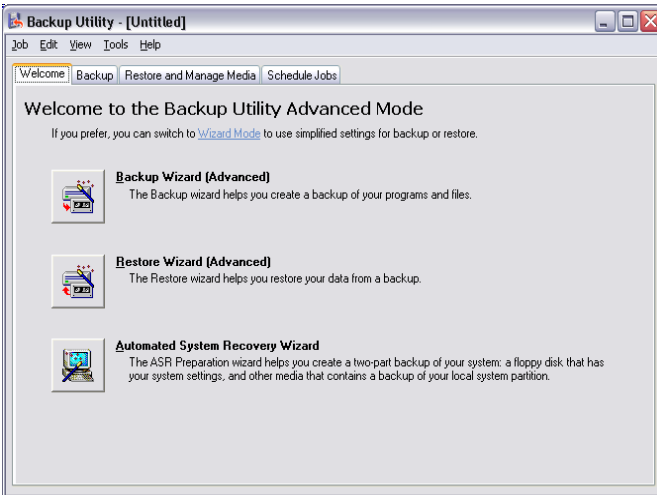

When Backup starts, follow the onscreen instructions to set up your backup profile and schedule.

For more information about Backup, refer to Windows XP help.



# Disk Defragmenter (Windows XP only)

The disk defragmentation utility consolidates files and folders on your computer's hard disk. This allows your computer to access files and folders and save new data more efficiently. By consolidating your files and folders, the defragmenter also consolidates the volume's free space, making it less likely that new files will be fragmented.

## How do I defragment my hard drive?

To run the Disk Defragmenter:

- 1 Click the Start button in the taskbar.
- 2 Highlight All Programs
- 3 Click Accessories
- 4 Select System Tools
- 5 Click Disk Defragmenter

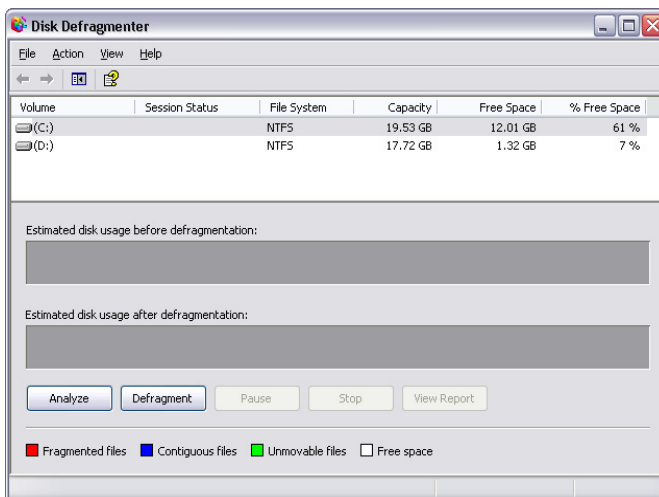

When Disk Defragmenter opens, select a drive/volume and click Analyze. The system will quickly examine the volume and determine whether it needs to be defragmented or not.

For more information about Disk Defragmenter, refer to Windows XP help.



# 6 Frequently asked questions

This chapter tells you what to do in case your computer is not working properly. However, if a more serious problem arises, contact your dealer or the technical support center ([www.acersupport.com](http://www.acersupport.com)) for assistance.

The following questions are possible situations that may arise during the use of your computer and each is followed by easy answers and solutions to the situation.

**Q:** I pressed the power switch but the system did not boot up.

**A:** Check the LED located beside the power switch.

If the LED is not lit, no power is being applied to the system. Do any of the following:

- Check if the voltage selector switch located on the rear panel of the computer is set to the correct voltage.
- Check if you plugged the power cable properly into an electrical outlet.
- If you are using a power strip or AVR, make sure that it is plugged in and turned on.

If the LED is lit, check the following:

- Is a nonbootable (nonsystem) diskette in the floppy drive? If yes, remove or replace it with a system diskette and press **Ctrl + Alt + Del** to restart your computer.
- The operating system files may be damaged or missing. Insert the startup disk you created during Windows setup into the floppy drive and press **Ctrl + Alt + Del** to restart your computer. This will automatically diagnose your system and make necessary fixes. However, if the diagnostic utility still reports a problem, then you may have to perform the recovery process to restore your system to its original default factory settings.



.....  
**Note:** For more information about recovering your system, refer to page 77.

**Q:** Nothing appears on the screen.

**A:** Your computer's power management function automatically blanks the screen to save power. Just press any key to turn the display back on.

If pressing a key does not work, contact your dealer or the technical support center for assistance.

**Q:** The printer does not work.

**A:** Do the following:

- Make sure that the printer is connected to a power outlet and that it is turned on.
- Make sure that the printer cable is connected securely to the system's parallel port and the corresponding port on the printer. See "Connecting your printer" on page 40 for information on how to connect the printer to your computer.
- For additional information concerning the printer, refer to the printer's documentation.

**Q:** No sound comes out from the computer.

**A:** Check the following:

- The volume may be muted. Look for the Volume icon on the taskbar. If it is crossed-out, click on the icon and deselect the **Mute** option. You can also press the volume control/mute knob on your USB keyboard to toggle from mute to sound on.
- If headphones, earphones, or external speakers are connected to the line-out jack of your computer, the internal or built-in speakers are automatically turned off.

**Q:** System cannot read diskette, hard disk, CD or DVD information.

**A:** Check the following:

- Make sure that you are using the correct type of disc. See page 22.
- Make sure the CD or DVD is inserted into the drive correctly.
- Check if the CD or DVD is clean and not scratched.
- Check your drive by using a good (i.e., undamaged) disc. If your drive can not read the information on the good disc there may be a problem with the drive. Contact your dealer or technical support center for assistance.

**Q:** System cannot write data on the hard disk or CD-R/CD-RW.

**A:** Check the following:

- Make sure the diskette or hard disk is not write-protected. Refer to the Optical drive section on page 22.
- Make sure that you are using the correct type of disc or diskette. Refer to the Optical drive section on page 22.





# Appendix A: Notices

## Energy Star Guidelines Compliance

As an Energy Partner, Acer Inc., has determined that this product meets the Energy Star guidelines for energy efficiency.

### FCC notice

This device has been tested and found to comply with the limits for a Class B digital device pursuant to Part 15 of the FCC Rules. These limits are designed to provide reasonable protection against harmful interference in a residential installation. This device generates, uses, and can radiate radio frequency energy and, if not installed and used in accordance with the instructions, may cause harmful interference to radio communications.

However, there is no guarantee that interference will not occur in a particular installation. If this device does cause harmful interference to radio or television reception, which can be determined by turning the device off and on, the user is encouraged to try to correct the interference by one or more of the following measures:

- Reorient or relocate the receiving antenna.
- Increase the separation between the device and receiver.
- Connect the device into an outlet on a circuit different from that to which the receiver is connected.
- Consult the dealer or an experienced radio/television technician for help.

### Notice: Shielded cables

All connections to other computing devices must be made using shielded cables to maintain compliance with FCC regulations.

### Notice: Peripheral devices

Only peripherals (input/output devices, terminals, printers, etc.) certified to comply with the Class B limits may be attached to this equipment. Operation with non-certified peripherals is likely to result in interference to radio and TV reception.

### FCC Caution

Any changes or modifications not expressly approved by the manufacturer could void the user's authority, which is granted by the Federal Communications Commission, to operate this computer.

## Use conditions

This part complies with Part 15 of the FCC Rules. Operation is subject to the following two conditions: (1) this device may not cause harmful interference, and (2) this device must accept any interference received, including interference that may cause undesired operation.

## Notice: Canadian users

This Class B digital apparatus meets all requirements of the Canadian Interference-Causing Equipment Regulations.

## Remarque à l'intention des utilisateurs canadiens

Cet appareil numérique de la classe B respecte toutes les exigences du Règlement sur le matériel brouilleur du Canada.

## Declaration of Conformity for EU countries

**Hereby, Acer, declares that this personal computer is in compliance with the essential requirements and other relevant provisions of Directive 1999/5/EC.**

## Modem notices

### Notice for USA

This equipment complies with Part 68 of the FCC rules. Located on the bottom side of the modem is a label that contains, among other information, the FCC Registration Number and Ringer Equivalence Number (REN) for this equipment. Upon request, you must provide this information to your telephone company.

If your telephone equipment causes harm to the telephone network, the telephone company may discontinue your service temporarily. If possible, they will notify you in advance. But, if advance notice is not practical, you will be notified as soon as possible. You will also be informed of your right to file a complaint with the FCC.

Your telephone company may make changes in its facilities, equipment, operations, or procedures that could affect the proper functioning of your equipment. If they do, you will be notified in advance to give you an opportunity to maintain uninterrupted telephone service.

If this equipment should fail to operate properly, disconnect the equipment from the phone line to determine if it is causing the problem. If the problem is with the equipment, discontinue use and contact your dealer or vendor.

CAUTION: To reduce the risk of fire, use only No. 26 AWG or larger UL Listed or CSA Certified Telecommunication Line Cord.

## TBR 21

This equipment has been approved [Council Decision 98/482/EC - "TBR 21 "] for pan-European single terminal connection to the Public Switched Telephone Network (PSTN). However, due to differences between the individual PSTNs provided in different countries, the approval does not, of itself, give an unconditional assurance of successful operation on every PSTN termination point. In the event of problems, you should contact your equipment supplier in the first instance.

## Notice for Australia

For safety reasons, only connect headsets with a telecommunications compliance label. This includes customer equipment previously labelled permitted or certified.

## Important safety instructions

**Read these instructions carefully. Save them for future reference.**

- 6 Follow all warnings and instructions marked on the product.
- 7 Unplug this product from the wall outlet before cleaning. Do not use liquid cleaners or aerosol cleaners. Use a damp cloth for cleaning.
- 8 Do not use this product near water.
- 9 Do not place this product on an unstable cart, stand, or table. The product may fall, causing serious damage to the product.
- 10 Slots and openings are provided for ventilation; to ensure reliable operation of the product and to protect it from overheating. These openings must not be blocked or covered. The openings should never be blocked by placing the product on a bed, sofa, rug, or other similar surface. This product should never be placed near or over a radiator or heat register, or in a built-in installation unless proper ventilation is provided.
- 11 This product should be operated from the type of power indicated on the marking label. If you are not sure of the type of power available, consult your dealer or local power company.
- 12 Do not allow anything to rest on the power cord. Do not locate this product where persons will walk on the cord.
- 13 If an extension cord is used with this product, make sure that the total ampere rating of the equipment plugged into the extension cord does not exceed the extension cord ampere rating. Also, make sure that the total rating of all products plugged into the wall outlet does not exceed the fuse rating.

- 14 Never push objects of any kind into this product through cabinet slots as they may touch dangerous voltage points or short out parts that could result in a fire or electric shock. Never spill liquid of any kind on the product.
- 15 Do not attempt to service this product yourself, as opening or removing covers may expose you to dangerous voltage points or other risks. Refer all servicing to qualified service personnel.
- 16 Unplug this product from the wall outlet and refer servicing to qualified service personnel under the following conditions:
  - c When the power cord or plug is damaged or frayed.
  - d If liquid has been spilled into the product.
  - e If the product has been exposed to rain or water.
  - f If the product does not operate normally when the operating instructions are followed. Adjust only those controls that are covered by the operating instructions since improper adjustment of other controls may result in damage and will often require extensive work by a qualified technician to restore the product to normal condition.
  - g If the product has been dropped or the case has been damaged.
  - h If the product exhibits a distinct change in performance, indicating a need for service.
- 17 Use only the proper type of power supply cord set (provided in your accessories box) for this unit. It should be a detachable type: UL listed/CSA certified, type SPT-2, rated 7A 125V minimum, VDE approved or its equivalent. Maximum length is 15 feet (4.6 meters).
- 18 Always disconnect all telephone lines from the wall outlet before serving or disassembling this equipment.
- 19 Avoid using a telephone line (other than cordless type) during an electrical storm. There may be a remote risk of electric shock from lightning.

## Macrovision copyright protection notice

**This product incorporates copyright protection technology that is protected by method claims of certain U.S. patents and other intellectual property rights owned by Macrovision Corporation and other rights owners. Use of this copyright protection technology must be authorized by Macrovision Corporation, and is intended for home and other limited viewing uses only unless otherwise authorized by Macrovision Corporation. Reverse engineering or disassembly is prohibited.**

Apparatus Claims of U.S. Patent Nos. 4,631,603, 4,577,216, 4,819,098, and 4,907,093 licensed for limited viewing uses only.

## Lithium battery statement

### **CAUTION**

Danger of explosion if battery is incorrectly replaced. Replace only with the same or equivalent type recommended by the manufacturer. Dispose of used batteries according to local regulations. Recycle if at all possible.

### **ADVARSEL!**

Lithiumbatteri - Eksplosionsfare ved fejlagtig håndtering. Udskiftning må kun ske med batteri af samme fabrikat og type. Léver det brugte batteri tilbage til leverandøren.

### **ADVARSEL**

Eksplosjonsfare ved feilaktig skifte av batteri. Benytt samme batteritype eller en tilsvarende type anbefalt av apparatfabrikanten. Brukte batterier kasseres i henhold til fabrikantens instruksjoner.

### **VARNING**

Explosionsfara vid felaktigt batteribyte. Använd samma batterityp eller en ekvivalent typ som rekommenderas av apparattillverkaren. Kassera använt batteri enligt fabrikantens instruktion.

### **VAROITUS**

Päristö voi räjähtää, jos se on virheellisesti asennettu. Vaihda paristo ainoastaan laitevalmistajan suosittelemaan tyyppiin. Hävitä käytetty paristo valmistajan ohjeiden mukaisesti.

### **VORSICHT!**

Explosionsgefahr bei unsachgemäßen Austausch der Batterie Ersatz nur durch denselben oder einem vom Hersteller empfohlenem ähnlichen Typ. Entsorgung gebrauchter Batterien nach Angaben des Herstellers.

## Laser compliance statement

The CD or DVD drive used with this computer is a laser product. The CD or DVD drive's classification label (shown below) is located on the drive.

CLASS 1 LASER PRODUCT

**CAUTION:** INVISIBLE LASER RADIATION WHEN OPEN. AVOID EXPOSURE TO BEAM.

APPAREIL A LASER DE CLASSE 1 PRODUIT

**LASERATTENTION:** RADIATION DU FAISCEAU LASER INVISIBLE EN CAS D'OUVERTURE. EVITER TOUTE EXPOSITION AUX RAYONS.

LUOKAN 1 LASERLAITE LASER KLASSE 1

**VORSICHT:** UNSICHTBARE LASERSTRAHLUNG, WENN ABDECKUNG GEÖFFNET NICHT DEM STRAHLL AUSSETZEN

PRODUCTO LÁSER DE LA CLASE I

**ADVERTENCIA:** RADIACIÓN LÁSER INVISIBLE AL SER ABIERTO. EVITE EXPONERSE A LOS RAYOS.

**ADVASEL:** LASERSTRÅLING VEDÅBNING SE IKKE IND I STRÅLEN.

VARO! LAVATTAESSA OLET ALTTINA LASERSÄTEILYLLE.

**WARNING:** LASERSTRÅLNING NÅR DENNA DEL ÅR ÖPPNAD ÅLÅ TUIJOTA SÄTEESEENSTIRRA EJ IN I STRÅLEN

**WARNING:** LASERSTRÅLNING NAR DENNA DEL ÅR ÖPPNADSTIRRA EJ IN I STRÅLEN

**ADVASEL:** LASERSTRÅLING NAR DEKSEL ÅPNESSTIRR IKKE INN I STRÅLEN

## Declaration of Conformity for CE marking

Name of Manufacturer: Acer Inc.  
 Address of Manufacturer: 8F, 88, Sec. 1, Hsin Tai Wu Rd.,  
 Hsichih, Taipei Hsien 221,  
 Taiwan, R. O. C.  
 Declares that product: Personal Computer  
 Model: Veriton 3600GT/3600V

Conforms to the EMC Directive 89/336/EEC as attested by conformity with the following harmonized standards:

EN55022:1994 /A2: 1997: Limits and Methods of Measurement of Radio Interference characteristics of Information Technology Equipment

EN55024: 1998/A1:2001: Information technology equipment--Immunity characteristics --Limits and methods of measurement

Including:

EN61000-4-2: 1995/A1: 1998/A2: 2001	EN61000-4-6: 1996/A1: 2001
EN61000-4-3: 1996/A1: 1998	EN61000-4-8: 1993/A1: 2001
EN61000-4-4: 1995/A2: 2001	EN61000-4-11: 1994/A1: 2001
EN61000-4-5: 1995/A1: 2001	

EN61000-3-2: 2000: Limits for harmonics current emissions

EN61000-3-3: 1995/A1: 2001: Limits for voltage fluctuations and flicker in low-voltage supply systems

Conforms to the Low Voltage Directive 73/23/EEC as attested by conformity with the following harmonized standard:

EN60950: 2000: Safety of Information Technology Equipment Including electrical business equipment. This equipment has been approved to Council Decision 98/482/EC (CTR21) for pan- European single terminal connection to the Public Switched Telephone Network (PSTN).

We, Acer Inc., hereby declare that the equipment bearing the trade name and model number specified above was tested conforming to the applicable Rules under the most accurate measurement standards possible, and that all the necessary steps have been taken and are in force to assure that production units of the same equipment will continue to comply with the requirements.

*Easy Lai*  
-----

2003/11/19  
-----  
Date



## Federal Communications Commission Declaration of Conformity

This device complies with Part 15 of the FCC Rules. Operation is subject to the following two conditions: (1) this device may not cause harmful interference, and (2) this device must accept any interference received, including interference that may cause undesired operation.

The following local Manufacturer /Importer is responsible for this declaration:

Product Name:	Personal Computer
Model:	Veriton 3600GT/3600V
Name of Responsible Party:	Acer America Corporation
Address of Responsible Party:	2641 Orchard Parkeay, San Jose CA 95134, U. S. A.
Contact Person:	David Lee
Phone No.:	408-922-5097
Fax No.:	408-922-5017



# Appendix B: Taking care of your computer

Please read the important instructions listed in this section. Following these instructions will help you maximize the durability of your computer.

## Important tips

- Do not expose the computer to direct sunlight. Do not place it near sources of heat, such as a radiator.
- Do not expose the computer to temperatures below 0°C (32°F), or above 40°C (104°F).
- Do not subject the computer to magnetic fields.
- Do not expose the computer to rain or moisture.
- Do not spill water on the computer.
- Do not subject the computer to heavy shock or vibration.
- Do not expose the computer to dust and dirt.
- Never place the system on uneven surfaces.
- Do not step on the power cord or place heavy objects on top of it. Carefully route the power cord and any cables away from personal traffic.
- When unplugging the power cord, do not pull on the cord itself but pull on the plug.
- The total ampere rating of the equipment plugged in should not exceed the ampere rating of the cord if you are using an extension cord. Also, the total current rating of all equipment plugged into a single wall outlet should not exceed the fuse rating.
- Check the documentation that came with your software programs to see if you can select other combinations of resolution and colour. These adjustments could make viewing the screen more comfortable.

## Cleaning and servicing

### To clean your computer and keyboard

- 1 Turn off the computer and unplug the power cord.

- 2 Use a soft cloth moistened with water and gently wipe the exterior of the computer and the keyboard. Do not use liquid or aerosol cleaners.

## To clean your pointing device

### To clean a regular mouse (with rubber ball)

- 1 Open the circular cover underneath the mouse.
- 2 Take out the rubber ball and wipe it with a soft, damp cloth.
- 3 Put the ball back and close the cover.

### To clean an optical mouse

For users of an optical mouse, refer to the documentation that came with your mouse for maintenance instructions.

## To clean your monitor

Make sure that you keep your screen clean. For cleaning instructions, refer to the documentation that came with your monitor.

## When to contact a service technician

- If you dropped and damaged the computer
- If liquid has been spilled into the computer
- If the computer is not operating normally
- If a computer problem persists even after you have checked and done the troubleshooting tips discussed in the “Frequently-asked questions” section on page 85.
- If your problem is not listed in the “Frequently-asked questions” section on page 85.
- If you want to replace or upgrade any of your computer’s internal components

## Asking for technical assistance

For technical assistance, contact your local dealer or distributor. You may also access the Web site ([www.acersupport.com](http://www.acersupport.com)) for information on how and where to contact the service centers available in your area.



# Index

## A

- accessing the user's guide 6
- applications 67

## B

- BIOS utility 75

## C

- computer maintenance 102
  - cleaning 102
  - servicing 102
- connecting options
  - multimedia devices 43
    - audio line-in device 45
    - earphones/headphones 44
    - external speakers 43
    - joystick 43
    - microphone 43
  - network 40, 42
  - printer 40
  - USB devices 46

## D

- disk drives
  - CD-ROM/DVD-ROM/CD-RW drive
    - inserting CDs/DVDs 22
    - taking care CDs/DVDs 23
  - hard disk 24

## F

- features 9
  - connectivity 9
  - multimedia 9
  - performance 9
- frequently asked questions 87
  - blank screen 88
  - no audio 88
  - no sound 88
  - printer not working 88
  - system did not boot up 87
- Frequently-asked questions
  - system cannot read disk 89
  - system cannot write to disk 89
- front panel 10

## I

- internal components 53
- internet/suspend key
  - email 15
  - suspend 15
  - web browser 15

## K

- keyboard 14
  - application key 20

## L

- lock keys
  - caps lock 18
  - num lock 18
  - scroll lock 18

## M

- mainboard
  - Veriton 3300 54
- multimedia key
  - forward 16
  - play/pause 16
  - stop 16

## N

- notice
  - DVD copyright protection 95
- NTI 72

## P

- PowerDVD 74

## R

- rear panel 12
- recovering your system 77
- remove computer cover 51

## S

- safety
  - CD-ROM 96
  - FCC notice 92
  - general instructions 94
  - modem notices 93
- setting up computer 27, 32
  - area 27
  - chair 27
  - connecting peripherals
    - external monitor 36
    - power cable 37

- USB keyboard 34
- USB mouse 32
- keyboard 30
- monitor 30
- mouse 31
- software 67
  - Norton AntiVirus 70
- system boards 54
  - audio board 57
  - mainboard 54
- system utilities
  - Acrobat Reader 68
  - Norton AntiVirus 70
  - NTI CD-Maker 72
  - PowerDVD 74
  - reinstalling programs 76

**T**

- turning off computer 39
  - software shutdown 39

- suspend mode 39
- turning on computer 38
  - power button 38

## U

- upgrade
  - add memory 58
    - install DDR DIMM 59
    - reconfigure computer 60
    - remove DDR DIMM 58
  - computer 54, 58
  - installation precautions 49
    - ESD 49
    - post-installation 50
    - preinstallation 49
  - open computer 51
    - remove computer cover 51
    - replace top cover 52
  - replace components 54
    - memory 58